

# INSTRUCTION MANUAL

## BUILT-IN BEVERAGE COOLER

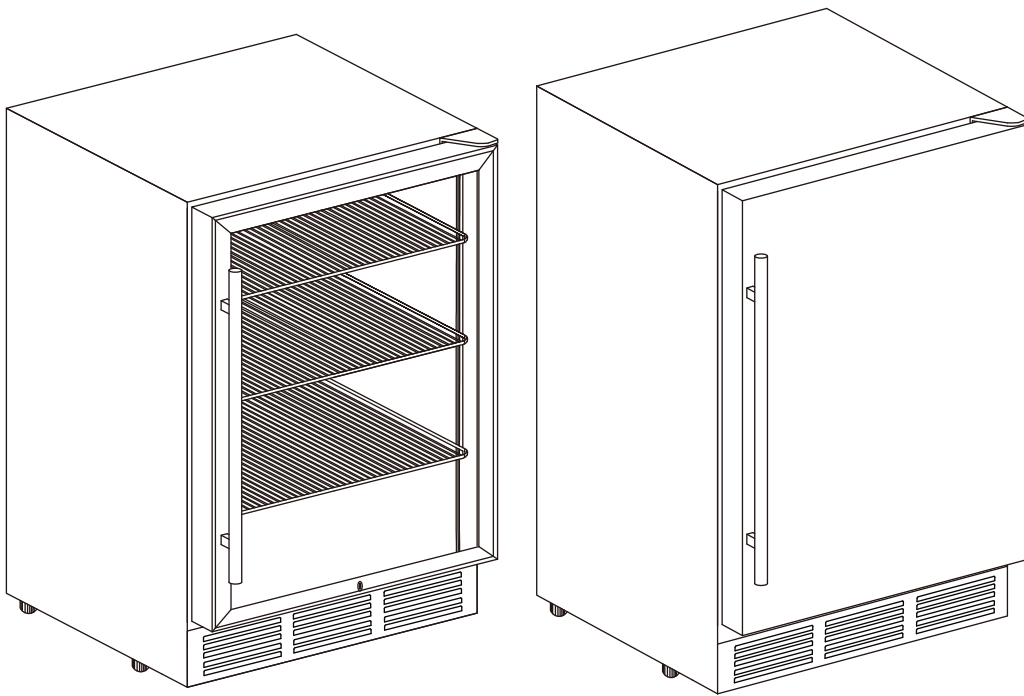

**MODEL: YC-150A/YC-150C**

**SKU: ZX-BRU-04-AZ-HM/ZX-RU-05-AZ-HM**

**Email: [support@homyd.com](mailto:support@homyd.com)**



## **TABLE OF CONTENTS**

<b>WARRANTY &amp; SERVICE</b>	3
<b>IMPORTANT SAFETY INSTRUCTIONS</b>	4
<b>PRODUCT DIAGRAM</b>	7
<b>BUILT-IN INSTALLATION</b>	8
<b>INSTALLATION INSTRUCTIONS</b>	9
Before Using Your Beverage Cooler	9
Installing the Stainless Steel Handle	9
To Install Your Beverage cooler	10
<b>OPERATION INSTRUCTIONS</b>	11
Controls	12
Shelves	13
Reversing the door	14
<b>CARE &amp; MAINTENANCE</b>	15
Cleaning the Beverage Cooler	15
Power Failure	15
Vacation Time	15
Moving the Beverage Cooler	16
Energy Saving Tips	16
<b>TROUBLESHOOTING GUIDE</b>	17

## **WARRANTY & SERVICE**

We offer a limited 1-year warranty ("warranty period") on all of our products purchased new and unused from us with an original proof of purchase and where a defect has arisen, wholly or substantially, as a result of faulty manufacture, parts, or workmanship during the warranty period. The warranty does not apply where damage is caused by other factors, including without limitation:

- (a) normal wear and tear;
- (b) abuse, mishandling, accident, or failure to follow operating instructions;
- (c) exposure to liquid or infiltration of foreign particles;
- (d) servicing or modifications of the product other than by our company.

Our warranty covers all costs related to restoring the proven-defective product through repair or replacement of any defective part and necessary labor so that it conforms to its original specifications. A replacement product may be provided instead of repairing a defective product. Our sole obligation under this warranty is limited to such repair or replacement. A receipt indicating the purchase date is required for any claim, so please keep all receipts in a safe place. Although appreciated, the product registration is not required to activate any warranty, and product registration does not eliminate the need for the original proof of purchase. The warranty will be voided if repairs are performed by a non-authorized third party and/or if spare parts other than those provided by the Company are used. You may also arrange for service after the warranty expires, at an additional cost. These are our general terms for warranty service, but we always urge our customers to reach out to us with any issue, regardless of warranty terms. If you have an issue with our products, please contact us ( [support@homyd.com](mailto:support@homyd.com) ), and we will do our best to resolve it for you.

## **IMPORTANT SAFETY INSTRUCTIONS**

Your safety and the safety of others are very important.

This beverage cooler complies with the applicable safety requirements and is safe for daily use. However, basic safety precautions should always be followed when using an electrical appliance to reduce the risk of fire, electric shock, or personal injury.



- Plug the cooler into its own individual electrical outlet with a voltage rating that matches the rating label on the cooler (**115/120V AC only, 60Hz**). Use receptacles that cannot be turned off by a switch or pull chain. Be sure that the plug is fully inserted into the receptacle.
- Plug the cooler into a grounded 3-prong outlet. Do not under any circumstances cut or remove the third ground prong from the power cord supplied.
- To protect against electric shock, do not immerse the beverage cooler, plug, or cord in water or other liquids.
- Never unplug the cooler by pulling the power cord. To disconnect the beverage cooler, always grip the plug firmly and pull it straight out from the wall outlet.
- Repair or replace immediately all power cords that have become frayed or otherwise damaged. Do not use a cord that shows cracks or abrasion damage along its length or at either end.
- Do not connect or disconnect the electric plug when your hands are wet. Do not operate the cooler with wet hands, while standing on a wet surface, or while standing in water.
- Unplug the beverage cooler or disconnect the power before cleaning or servicing. Failure to do so can result in electrical shock or death.
- When moving the beverage cooler, be careful not to roll over or damage the power cord.
- Never clean beverage cooler parts with flammable fluids, which can create a fire hazard or explosion. Do not store or use gasoline or other flammable materials or liquids in the vicinity of this or any other appliance. The fumes can cause a fire hazard or explosion.
- Do not attempt to repair or replace any part of your beverage cooler unless it is specifically recommended in this manual. All other servicing should be referred to a qualified technician.
- An empty beverage cooler can be dangerous to children. Remove any latches, lids, locks, and/or doors from unused or discarded beverage coolers to prevent child entrapment and suffocation. Never allow children to operate, play with, or crawl inside this beverage cooler.



## WARNING



- Moving this beverage cooler requires two people. Failure to do so can result in injury.
  - Place this beverage cooler in a well-ventilated area with temperatures above 15°C (60°F) and below 32°C (90°F).
  - To ensure proper ventilation for your beverage cooler, the front of the cooler must be completely unobstructed.
  - This beverage cooler must be installed in an area away from wind, rain, water spray, or drips.
  - The beverage cooler should not be located next to an oven, grill, or other source of high heat.
  - Do not kink or pinch the power supply cord of the beverage cooler.
  - It is important for the beverage cooler to be leveled in order to work properly. You may need to make several adjustments to level it.
  - This beverage cooler is designed for storing and cooling wines. Do not store perishable food or medical products in the cooler.
  - When disposing of refrigeration beverage coolers, special handling is often required. It is the consumer's responsibility to comply with federal and local regulations when disposing of this product.
  - **WARNING:** Risk of child entrapment and suffocation. Before you throw away this or any old cooler, remove the door. Leave the shelves in place so that children may not easily climb inside.
1. This appliance is not intended for use by persons (including children) with reduced physical, sensory, or mental capabilities or lack of experience and knowledge unless they have been properly instructed on the use of the appliance by a person responsible for their safety.
  2. Children should be supervised to ensure that they do not play with the appliance.
  3. This appliance can be used by children aged eight years and above and persons with reduced physical, sensory, or mental capabilities or lack of experience and knowledge if they have been properly instructed on the safe use of the appliance and understand the hazards involved. Children shall not play with the appliance. Cleaning and user maintenance shall not be made by children without supervision.
  4. If the supply cord is damaged, it must be replaced by the manufacturer, its service agent, or a similarly qualified person in order to avoid hazards.
  5. Any instability of the appliance must be repaired in accordance with these instructions to avoid hazards.

6. When positioning the appliance, ensure the power supply cord is not tangled or damaged.
7. Do not connect portable extensions or power supplies to the rear of the appliance.
8. Keep ventilation openings, in the appliance enclosure or the built-in structure, clear of obstruction.
9. Do not use mechanical devices or other means to accelerate defrosting, other than those recommended by the manufacturer.
10. Do not damage the refrigerant circuit.
11. Do not use electrical appliances inside the drink storage compartments of the appliance unless they are of the type recommended by the manufacturer.
12. Do not store explosive substances such as aerosol cans with a flammable propellant in this appliance.
13. This appliance is intended for household and similar applications such as offices,
  - staff kitchen areas in shops, and other work environments;
  - in farmhouses and by clients in hotels, motels, and other residential-type environments;
  - bed and breakfast environments;
  - catering and similar non-retail applications.
14. To avoid contamination of drinks, please respect the following instructions:
  - Opening the door for long periods can cause a significant increase in the temperature in the compartments of the appliance.
  - Regularly clean surfaces that can come in contact with drinks and accessible drainage systems.
  - Clean water tanks if they have not been used for 48 hours, and flush the water system connected to a water supply if water has not been drawn for five days.
  - If the cooler will be left empty for long periods, switch off, defrost, clean, and dry the appliance and leave the door open to prevent mold from developing inside.



**WARNING: Risk of fire / flammable materials**

The coolant circuit of this unit contains the refrigerant Isobutane (R600a), a natural gas that is flammable and of high environmental compatibility. Make sure no parts of the coolant circuit get damaged during transport and installation of the appliance.



## FLAMMABLE REFRIGERANT GAS



**DANGER** - Risk of fire or explosion. Flammable refrigerant used.

**DO NOT use mechanical devices to defrost the refrigerator. DO NOT puncture refrigerant tubing.**

**DANGER** - Risk of fire or explosion. Flammable refrigerant used. To be repaired only by trained service personnel. DO NOT puncture refrigerant tubing.

**CAUTION** - Risk of fire or explosion. Flammable refrigerant used. Consult repair manual / owner's guide before attempting to service this product. All safety precautions must be followed.

**CAUTION** - Risk of fire or explosion. Dispose of property in accordance with federal and local regulations. Flammable refrigerant used.

**CAUTION** - Risk of fire or explosion due to puncture of refrigerant tubing. Follow handling instructions carefully. Flammable refrigerant used.

**CAUTION** - To prevent a child from being entrapped, keep children away from the vicinity of the cooler.

### PRODUCT DIAGRAM

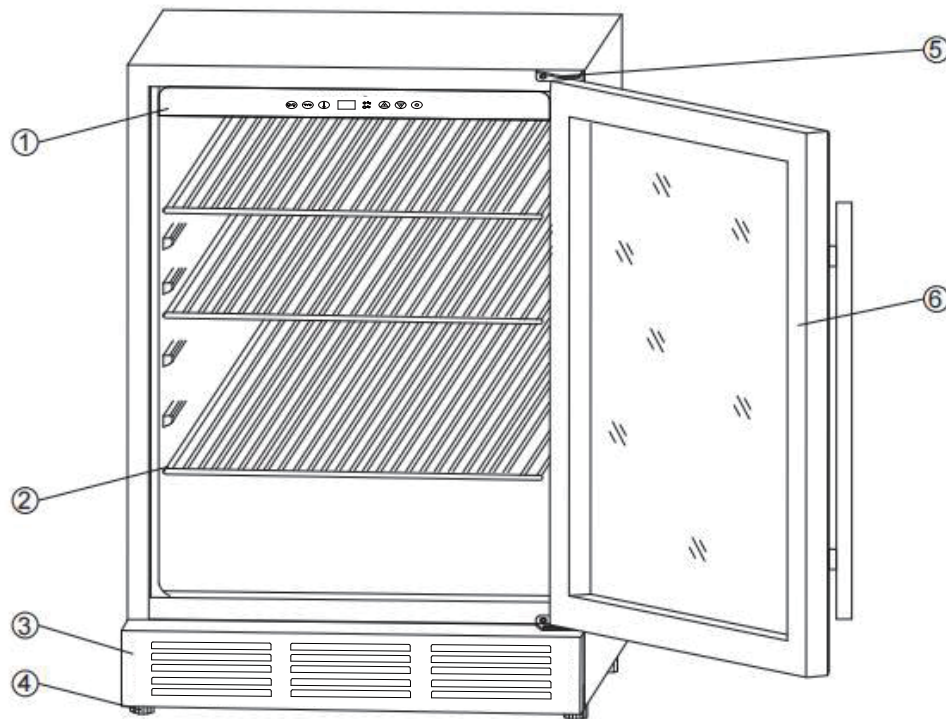

1 Control Panel

2 Shelves

3 Front Vent

4 Leveling Legs

5 Top Hinge

6 Glass Door with Handle



# BUILT-IN INSTALLATION

These appliances are designed for both built-in or free-standing installation. For built-in installation, ensure proper service access and ventilation, and allow at least .25" (6.35mm) space on each side and at the top.

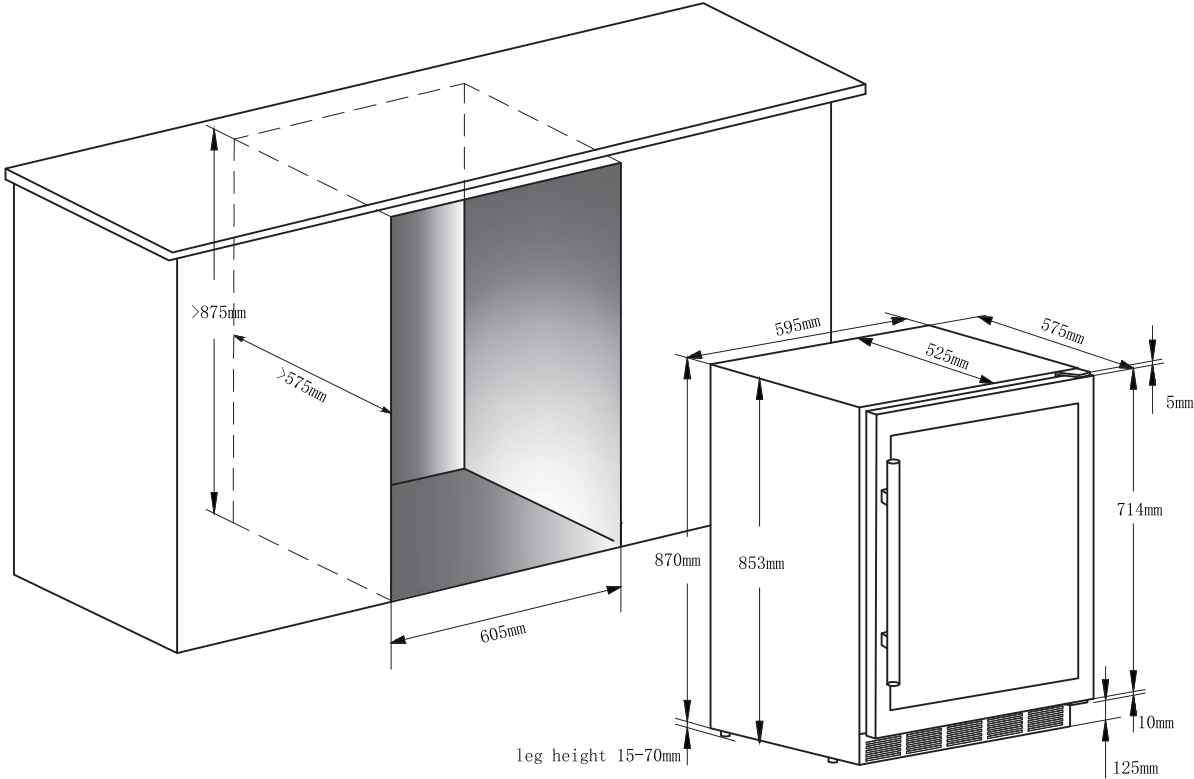

## **INSTALLATION INSTRUCTIONS**

### **Before Using Your Beverage Cooler**

- Remove the exterior and interior packaging.
- Check to be sure you have all of the following parts:
  - o 3 Shelves
  - o Stainless Steel Handle
  - o Instruction Manual
  - o 2 Extra Screws for Installing the Handle
- **IMPORTANT:** Before connecting this beverage cooler to a power source, let it stand upright for approximately **24 hours**. This will reduce the possibility of a malfunction in the cooling system from handling during transportation.
- Clean the interior surface with lukewarm water using a soft cloth.
- Install the handle on the left side of the door.

### **Installing the Stainless Steel Handle**

1. Pull away the door gasket in the area where the handle is to be installed, as in Illustration #1.
2. The gasket is easily removed by hand, no tools are necessary.
3. Align the handle with the pre-installed screws on the door frame. Tighten the screws with a screwdriver until the handle secures tightly against the door frame, as in Illustration #2. (Do NOT over-tighten as this will cause damage to the handle assembly).
4. Replace the door gasket to its original position.

**Note:** This beverage cooler includes a stainless steel handle that is not required to operate the cooler. If you choose not to use the handle supplied, simply follow step 1 to access the pre-installed screws, remove them, and then place 2 decorative plugs (NOT included) into the two holes separately. Continue on to step 3 to replace the door gasket to its original position.

Illustration #1

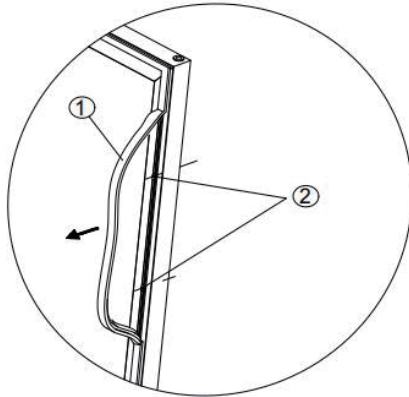
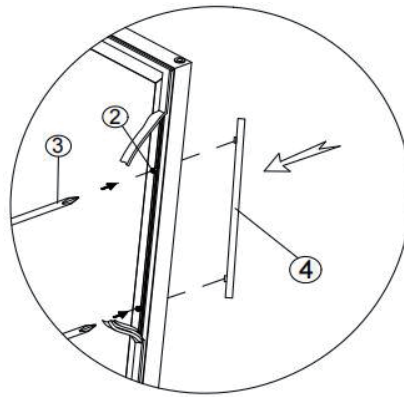

Illustration #2



- 1 sealing
- 2 screws
- 3 Phillips screwdriver
- 4 Handle

### **To Install Your Beverage Cooler**

- This beverage cooler is designed for free-standing or built-in (fully recessed) installation.
- Place your beverage cooler on a solid and level floor that is strong enough to support it when it is fully loaded. This will ensure a vibration-free and noise-free operation. Adjust the leveling legs in and out to stabilize the cooler horizontally. If the legs are not properly adjusted, the cooler may be unstable and result in excess noise or vibration.
- Locate the beverage cooler away from direct sunlight and sources of heat (stove, heater, radiator, etc.). Direct sunlight may affect the acrylic coating, and heat sources may increase electrical consumption. Extremely cold ambient temperatures may also cause the cooler not to perform properly.
- It is not advisable to install this cooler in moist areas or directly adjacent to a kitchen sink as moisture could cause premature corrosion to the components of your new cooler.
- It is recommended you install the beverage cooler in a place with temperatures **above 60°F (15°C) and below 90°F (32°C)** and humidity under 60%. If the ambient temperature is above or below the recommended temperatures, the performance of the cooler may be affected. Placing your cooler in an extremely cold or hot environment may cause interior temperatures to fluctuate, and the temperature range of 3°C-18°C (37°F-65°F) may not be reached.

- Connect the beverage cooler to an exclusive, properly grounded, standard electrical supply **(115 V AC only, 60 Hz)** in accordance with federal and local codes and ordinances. Any questions concerning power and/or grounding should be directed toward a certified electrician or an authorized products service center.

**⚡Warning⚡:** Improper use of the grounded plug can result in electrical shock. If the power cord is damaged, have it replaced by an authorized service center.

- The beverage cooler should always be plugged into its own individual electrical outlet which has a voltage rating that matches the rating label on the beverage cooler. This provides the best performance and also prevents overloading house wiring circuits that could cause a fire hazard from overheating.
- Do not under any circumstances cut or remove the third ground prong from the power cord supplied.
- Do not use an extension cord or adapter plug. However, if you must use an extension cord, it is absolutely necessary that it be a UL-listed, 3-wire grounding type beverage cooler extension cord with a grounding type plug and outlet and that the electrical rating of the cord is 10 amperes (minimum) and 120 volts.
- Do not use a cord that shows cracks or abrasion damage along its length or at either end.
- If the beverage cooler will be used in an area that is prone to power surges/outages, it is suggested that you use a power surge protector. The surge protector that you select must have a surge block high enough to protect the beverage cooler it is connected to. Damage due to power surges is not considered a manufacturer-covered defect and will void your product warranty.

## **OPERATION INSTRUCTIONS**

TEMPERATURE SETTING RANGE: 3°C(37°F) and 18°C (65°F)

### **Recommended temperature settings**

**Beverage: 3°C -10°C (37°F - 50°F)**

**Sparkling wines:5°C -8°C (41°F - 46°F)**

**Dry/white wines: 9°C - 14°C (48°F - 57°F)**

**Rose Wines 10°C - 11°C (50°F - 52°F)**









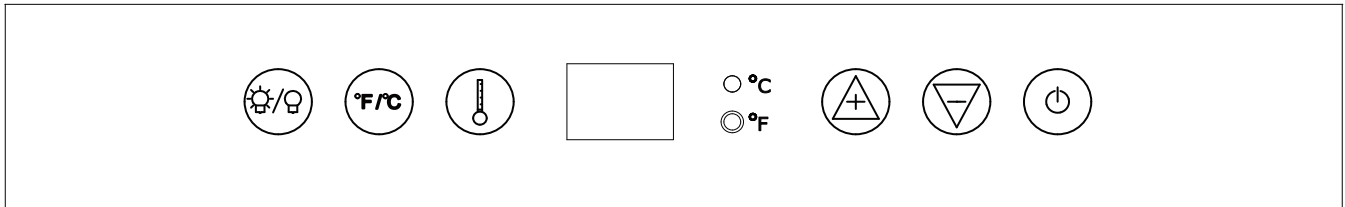

**Red wines: 15°C - 18°C (59°F - 64°F)**

## **Controls**

After plugging the beverage cooler into a wall outlet, the cooler will turn on automatically, and the LCD screen will display the temperature inside of the cooler.

After setting your desired serving temperature, allow the cooler to cool down for **3 to 4 hours** before placing wine bottles in the beverage cooler.



	Press once to turn ON the cooler. Press and hold  about 3 seconds to turn OFF the cooler.
 	Press  to increase or press  to decrease the temperature in 1 degree increments between 3°C and 18°C or between 37°F and 65°F.
	Press to begin adjusting the temperature.
	Toggles the temperature display between Celsius and Fahrenheit.
	Press  once to turn the interior light ON or OFF.

## **Storage**

Cans and bottles may differ in size and dimensions. As such, the actual number of bottles you may be able to store may vary.

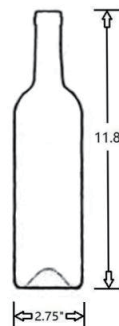

The stated capacity is dependent on the size and shape of a standard Bordeaux 750ml bottle with a diameter of 2.75".

When accommodating larger bottles, you can remove shelves. This will reduce the stated bottle capacity.

## **Shelves**

The appliance is equipped with three wired shelves. The shelves have telescopic rails designed with a stopper on each side of the shelf track to prevent bottles from falling.

You can remove a shelf by lifting it and pulling it out smoothly.

Before removing a shelf from the appliance, it is necessary to remove all the bottles on the shelf.

To prevent damage to the door gasket, make sure to open the door all the way before pulling the shelves out.

**Removing a shelf:** Move the shelf to the position where the notch of the wired shelf is directly under the stopper and lift the shelf. Please ensure these are replaced when the shelf is put back.

**Re-inserting the shelf:** align the shelf to the STOPPER position and push it back to make sure the shelf is properly engaged. Make sure the shelves are fully engaged before loading any bottles.

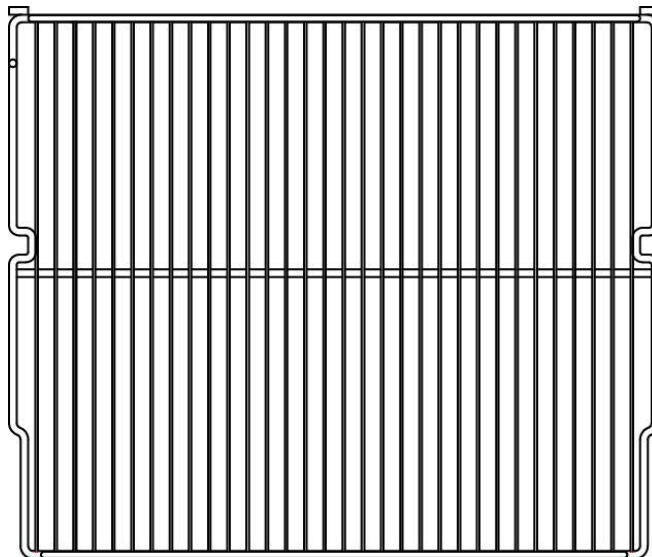

## Reversing the door

The door is reversible. The default way to open the door is from the left. If you need to reverse the door, follow these diagrams:

Model: Foam Door YC-150C SKU: ZX-RU-05-AZ-HM

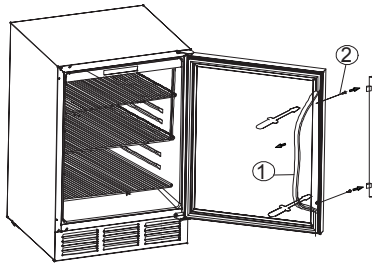

Fig: 1

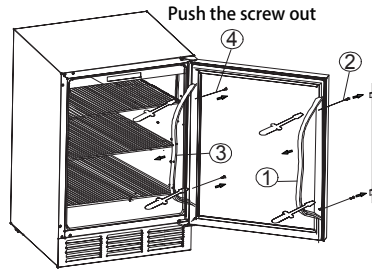

Fig: 2

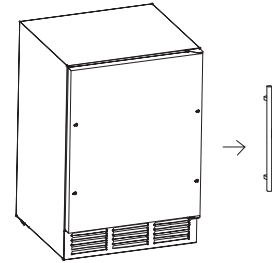

Fig: 3

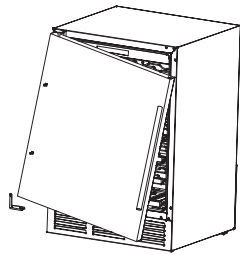

Fig: 4

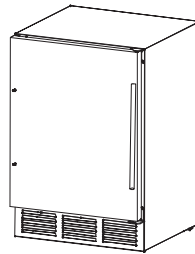

Fig: 5

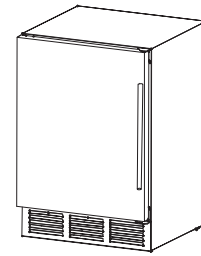

Fig: 6

Model: Glass Door YC-150A SKU: ZX-BRU-04-AZ-HM

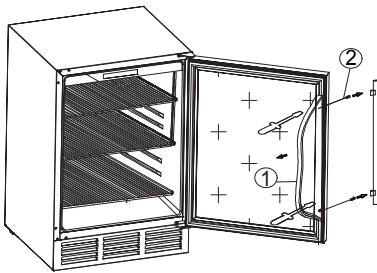

Fig: 1

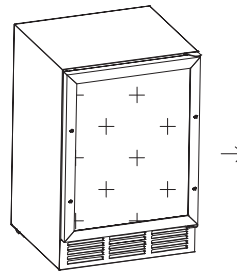

Fig: 2

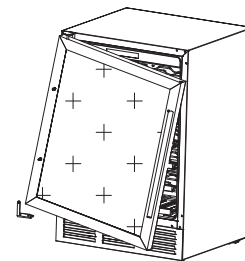

Fig: 3

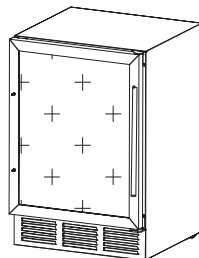

Fig: 4

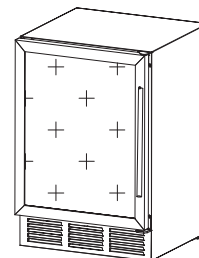

Fig: 5

## **CARE & MAINTENANCE**

### **Cleaning the Beverage Cooler**

**IMPORTANT:** Always unplug the cooler before cleaning or performing maintenance. Never use harsh cleansers or scouring pads to clean any part of the cooler.

- Turn off the power, unplug the beverage cooler, and remove all items including shelves.
- Wash the inside surfaces with a solution of warm water and baking soda. The solution should be about two tablespoons of baking soda to one quart of water.
- Wash the shelves with a mild detergent solution.
- Wring excess water out of the sponge or cloth when cleaning the area near the controls, or any electrical parts.
- Wash the outside cabinet with warm water and a mild liquid detergent. Rinse well and wipe dry with a clean soft cloth. Do not use steel wool or a steel brush to scrub the stainless steel, which will contaminate the stainless steel with steel particles, and rusting may occur.

**NOTE:** If you use our products outdoors, be sure to promptly clean up any dust or water stains to extend the lifespan of the product.

### **Power Failure**

Most power failures are corrected within a few hours and should not affect the temperature of your beverage cooler. If the power is off for an extended period of time, proper steps should be taken to protect the contents.

### **Vacation Time**

Leave the beverage cooler operating during vacations of less than three weeks. For longer periods, turn the beverage cooler off and leave the door slightly ajar to prevent odor from building up in the cooler.





### **Moving the Beverage Cooler**

- Remove all items (bottles) from the cooler;
- Securely tape down any loose items, such as shelves, inside the cooler.
- Turn the adjustable leg up to the base to avoid damage.
- Tape the door shut.
- Ensure that the beverage cooler stays securely in the upright position during transportation. Protect the outside of the beverage cooler with a blanket or similar item.

### **Energy Saving Tips**

- The cooler should be located in the coolest area of the room away from heat sources or direct sunlight.
- Ensure that the cooler is adequately ventilated. Never cover air vents.
- Only open the cooler door for as long as necessary. Frequently opening the door will affect internal temperature.

## TROUBLESHOOTING GUIDE

<b>PROBLEM</b>	<b>POSSIBLE CAUSE</b>	<b>SOLUTION</b>
The beverage cooler does not run.	The beverage cooler may not be plugged in, or the plug may be loose.	Ensure the beverage cooler has been plugged in properly.
	The beverage cooler is turned off.	Press  to turn on the cooler.
	House fuse blown or tripped circuit breaker.	Check/replace fuse. Reset circuit breaker.
The beverage cooler is not cold enough.	External environment may require a higher setting.	Set a colder setting. Allow several hours for the temperature to stabilize.
	The beverage cooler has recently been disconnected for a period of time.	It takes 3-4 hours for the beverage cooler to cool down completely.
	Prolonged or frequent door openings.	Open the door less often.
	The door is not closed completely.	Close the door properly.
	The door gasket does not seal properly.	Check the door gasket. Clean or change gasket if necessary.
The compressor turns on and off frequently.	The room temperature is hotter than normal.	It's normal for the beverage cooler to work harder under these conditions.
	A large amount of contents has been added to the cooler.	A large amount of content causes the beverage cooler to run more often until the desired temperature is reached.
	Prolonged or frequent door openings.	Open the door less often.
	The temperature has not been set correctly.	Press either  or  to check the set temperature, and set the temperature properly.
	The door is not closed completely.	Close the door properly.
	The door gasket does not seal properly.	Check the door gasket. Clean or change gasket if necessary.

<b>PROBLEM</b>	<b>POSSIBLE CAUSE</b>	<b>SOLUTION</b>
The light does not work.	Not plugged in.	Plug the cooler in.
	The circuit breaker tripped or a blown fuse.	Check the breaker and/or fuses.
	The light button is "OFF".	Press  to turn the light ON.
Vibrations.	The cooler is not leveled.	Check to assure that the cooler is level.
	The bottles are vibrating.	Make sure the bottles don't touch each other.
	There is an object under the cooler.	Remove the object under the cooler.
The cooler seems to make too much noise.	The cooler is not level.	Level the cooler.
	Normal noise from the flow of the refrigerant.	The rattling noise may come from the flow of the refrigerant, which is normal. As each cycle ends, you may hear gurgling sounds caused by the flow of refrigerant in your cooler. Contraction and expansion of the inside walls may cause popping and crackling noises.
The door will not close properly.	The cooler is not level.	Level the cooler.
	The door was reversed and not properly installed.	Re-install the door properly.
	The gasket is dirty.	Clean the door gasket.
	The shelves are out of position.	Place the shelves properly.
Moisture build-up on interior or exterior of the beverage cooler.	This is normal during high humidity periods.	Lower the room humidity.
	This is normal in a high-temperature.	Move the cooler to a cooler place, and avoid heat and sunlight.
	Prolonged or frequent door openings.	Open the door less often.
	The door does not seal completely.	Check door gaskets for proper seal.
Error Code: E1-E2-E3-E4-E7-E8	A sensor has failed.	Contact customer service.

